

ASSEMBLY INSTRUCTION

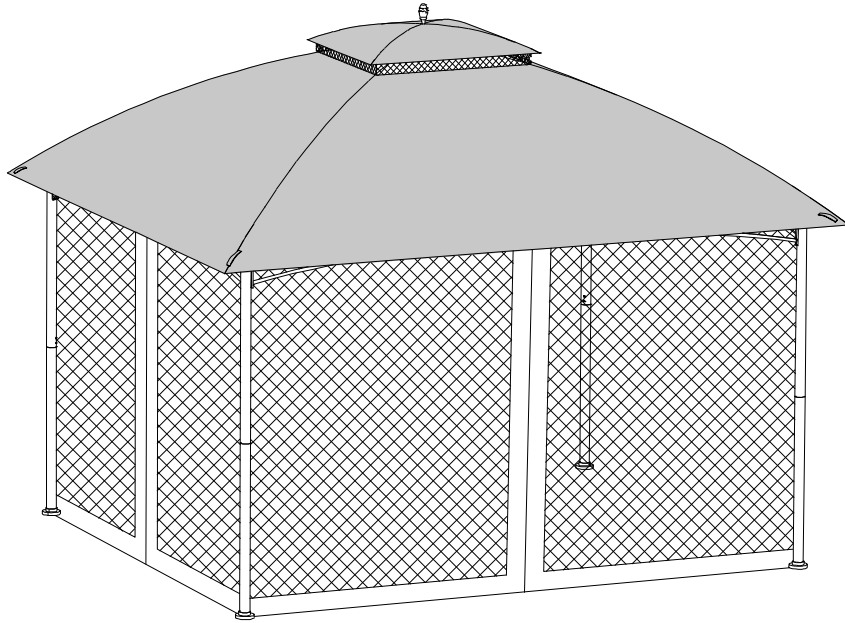

WE HAVE YOU IN MIND, LET US SERVE YOU!

Questions? Issues?

CONTACT US

24 hours / 7 days a week

Safety Information

- Three people are required for this assembly.
- Some parts may contain sharp edges. Wear protective gloves.
- When assembling and using this product, basic safety precautions should always be followed to reduce the risk of personal injury and damage to equipment. Please read all instructions before assembly and usage.



CAUTION: Chair is for setting purpose only. Standing on or misuse of chair may result in damage or injury. Not intended for commercial use. **WEIGHT LIMIT 250LBS(113.5KG)**

NOTICE: For outdoor use only.



DANGER: This unit is heavy! Do not assemble this item alone.



WARNING: Do not leave the gazebo where there is a risk of high wind, as possible damage will occur to the structure.



WARNING: Keep all flame and heat sources away from this gazebo fabric. This Gazebo is made with fabric that meets CPAI-84 specifications for flame resistance. It is not fire proof. The fabric will burn if left in continuous contact with any flame source. The application of any foreign substance to the gazebo fabric may render the flame-resistant properties ineffective.

Warranty: 1 Year

WHAT IS COVER?

The limited warranty is extended to the original purchaser and applies to material and manufacturer's defect provided the item is maintained with care and used only for personal, residential purposes.

IMPORTANT





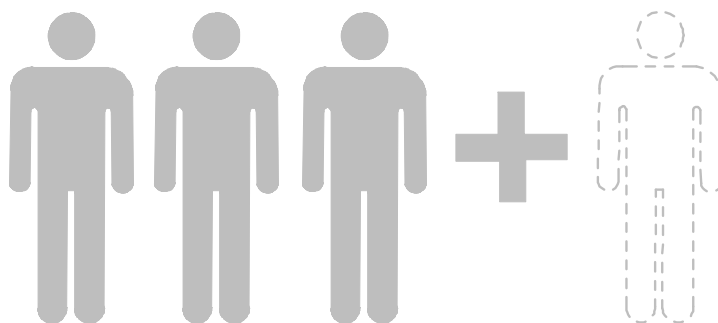



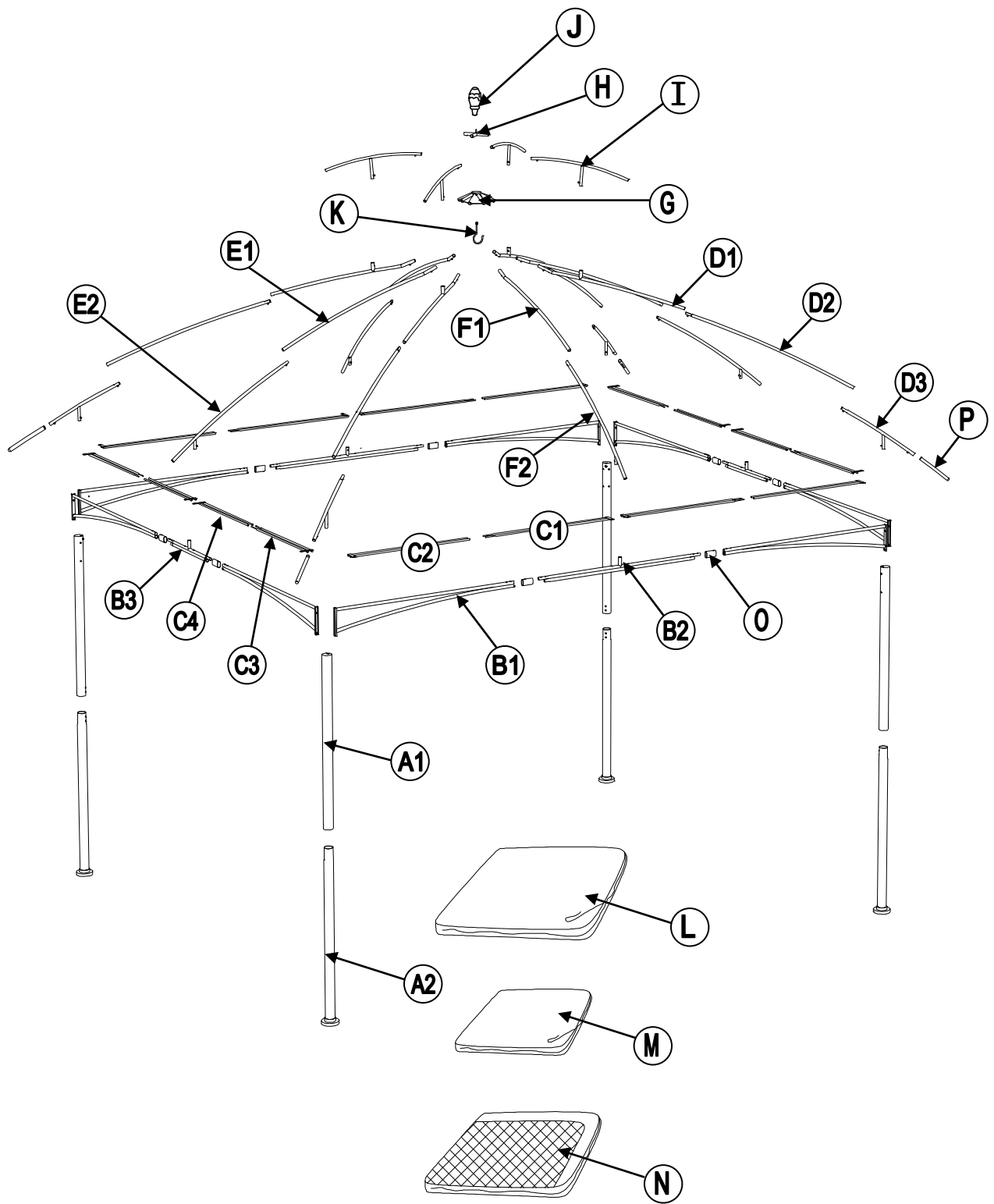

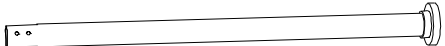

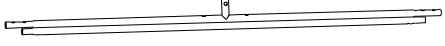



KEEP THIS INSTRUCTION MANUAL FOR FUTURE REFERENCE.



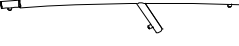



How many people needed for the installation work

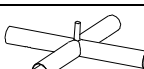

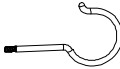

EXPLODED DRAWING

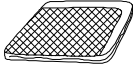

Parts List				
Label		Description	Qty	Part Image
A1		Post 1	4	
A2		Post 2	4	
B1		Cross Beam	8	
B2		Long Cross Beam	2	
B3		Short Cross Beam	2	
C1		Long Netting Rod 1	4	
C2		Long Netting Rod 2	4	
C3		Short Netting Rod 1	4	
C4		Short Netting Rod 2	4	
D1		Big Roof Upper Rafter	4	
D2		Big Roof Middle Rafter	4	
D3		Big Roof Lower Rafter	4	
E1		Long Joist (Upper)	2	
E2		Long Joist (Lower)	2	
F1		Short Joist (Upper)	2	
F2		Short Joist (Lower)	2	
G		Big Connector	1	
H		Small Connector	1	

I	Small Roof Rafter	4	
J	Finial	1	
K	Hook	1	
L	Small Canopy	1	
M	Big Canopy	1	
N	Mosquito Netting	1	
O	Plastic Cap	8	
P	Adjustable Tube	4	

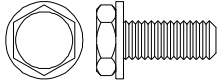
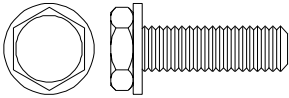
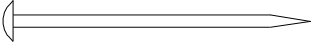
Hardware Pack

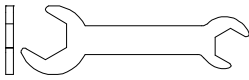
Label	Description	Qty	Add	Part Image
AA	Bolt M5*15	24	2	
BB	Bolt M6*20	40	2	
CC	Stake Φ8*180	8	0	
DD	Brown Plastic Ring	52	3	
EE	Wrench M5/ M6	1	0	

1

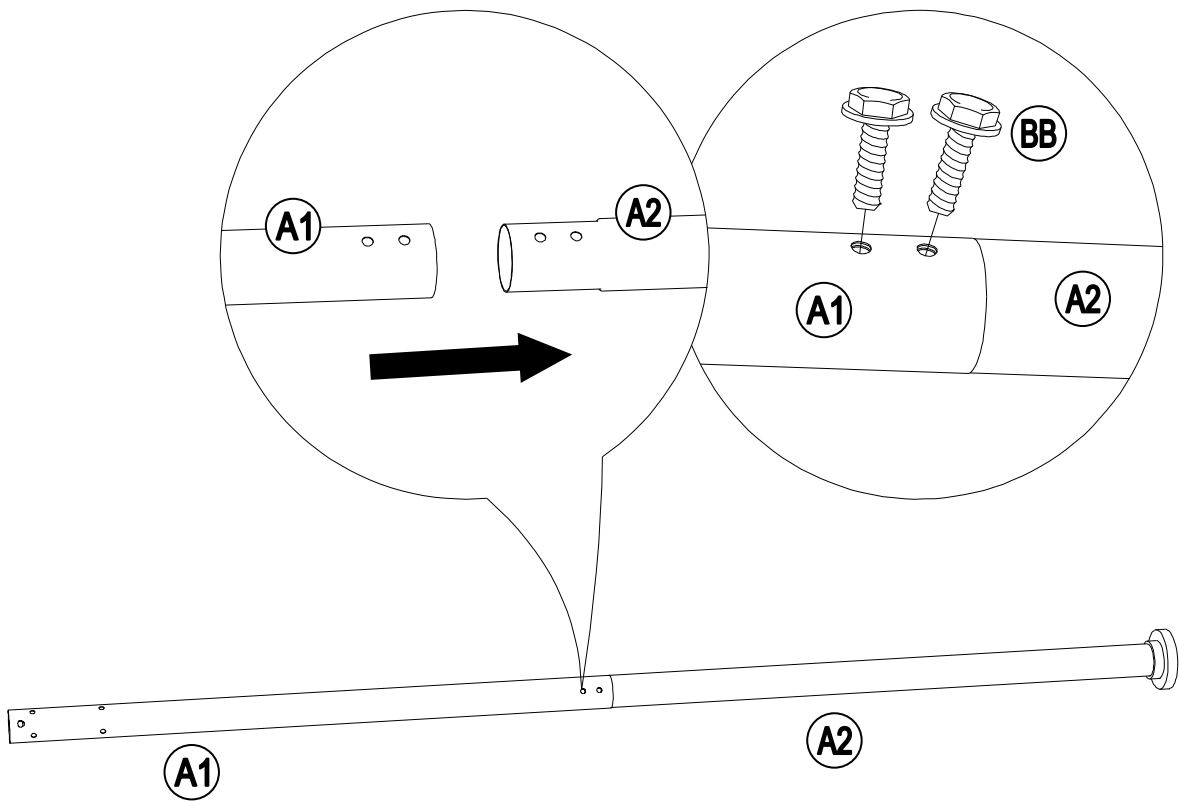
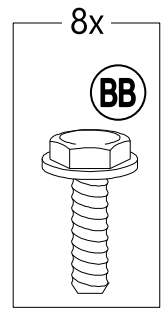
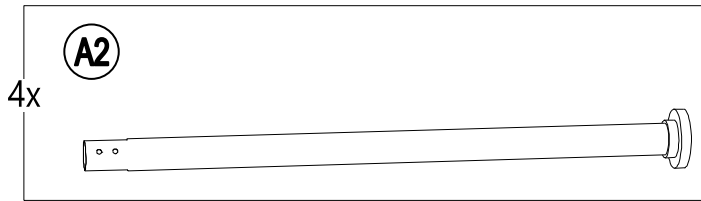
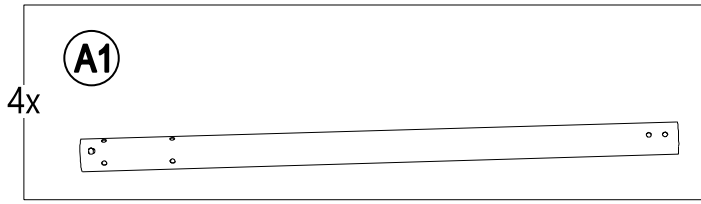

2

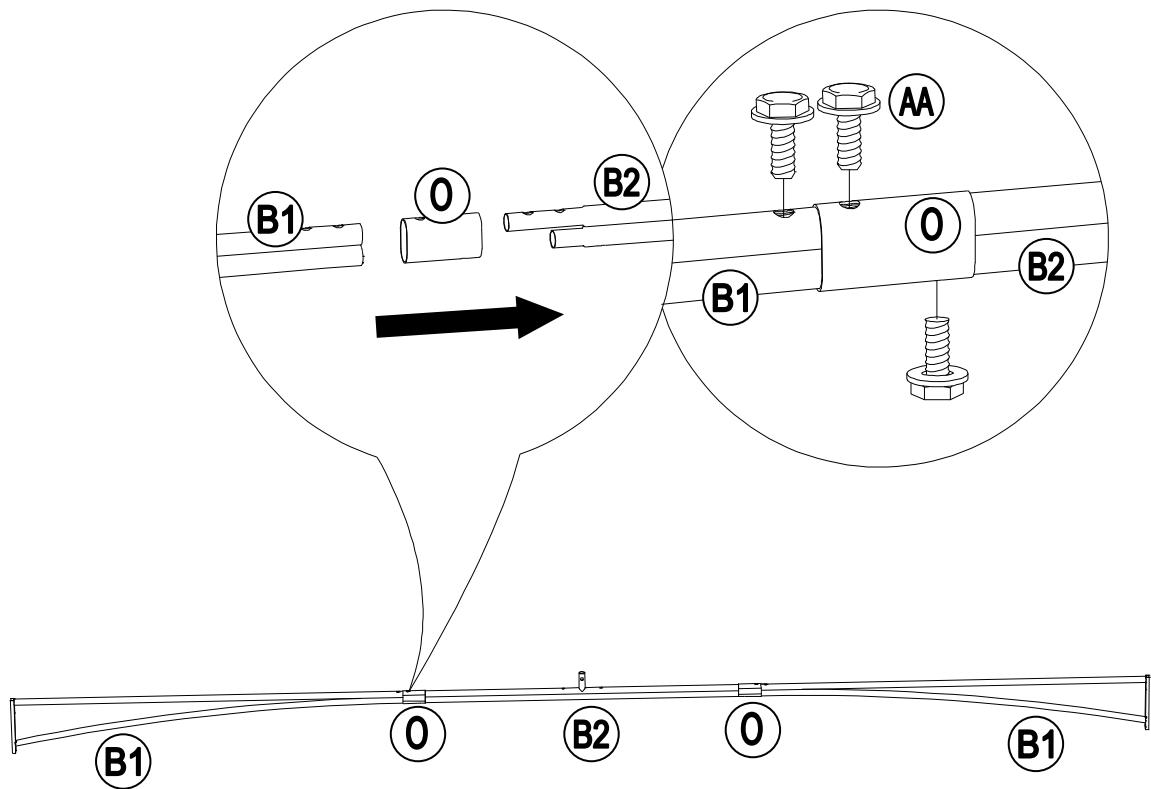
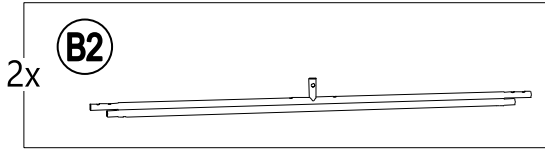
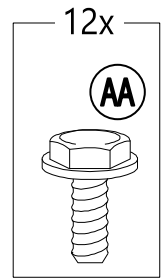
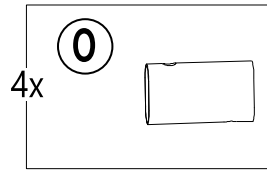
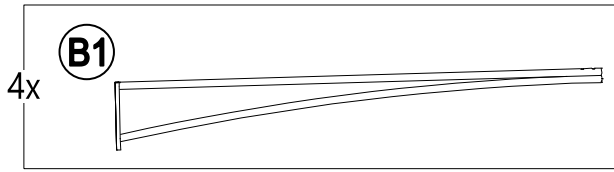

3

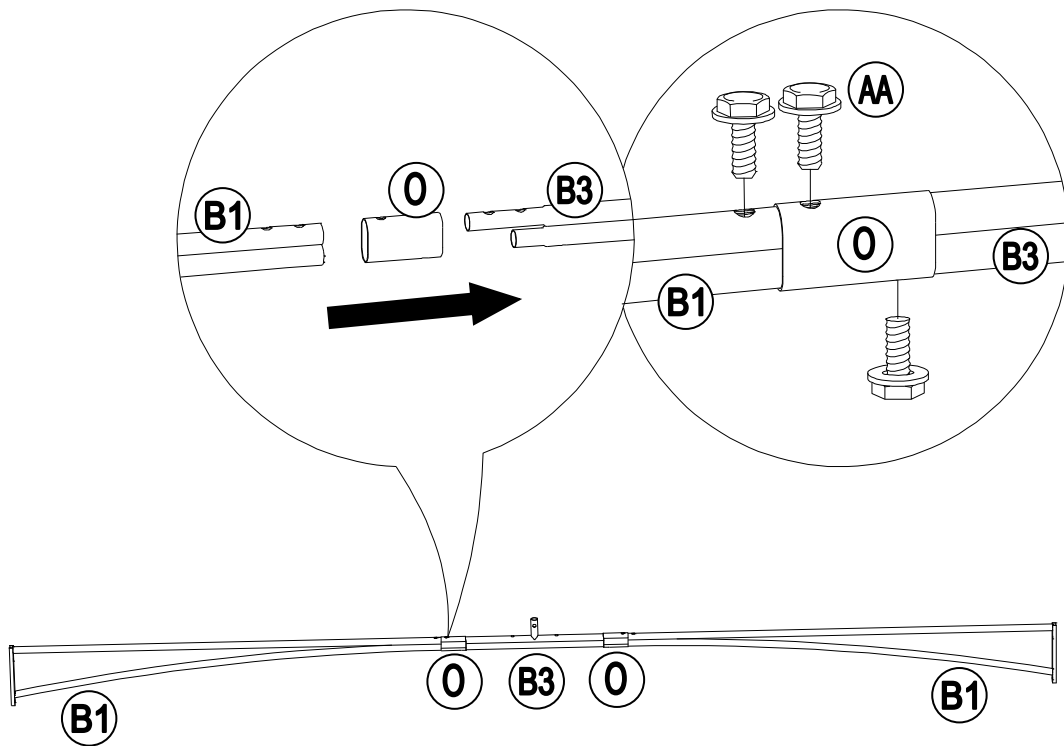
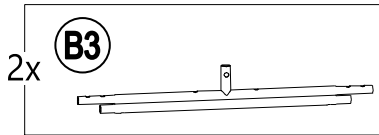
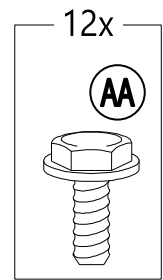
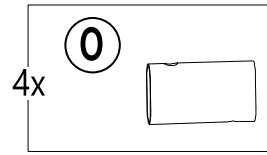
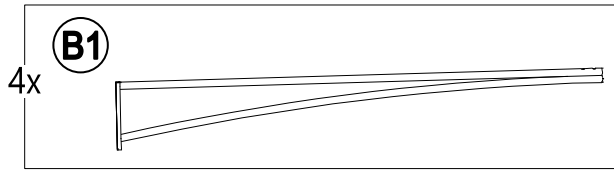

4

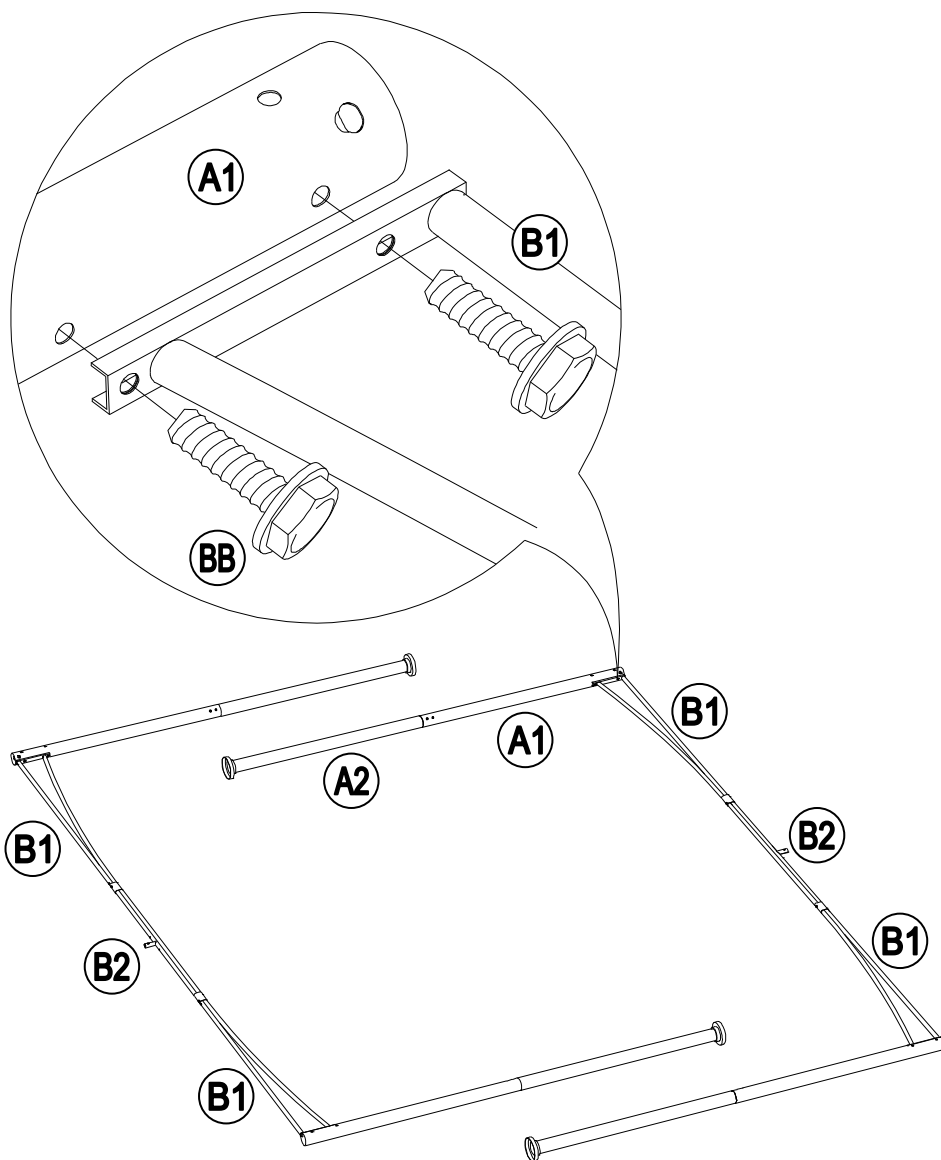
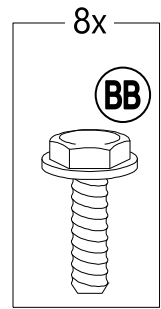
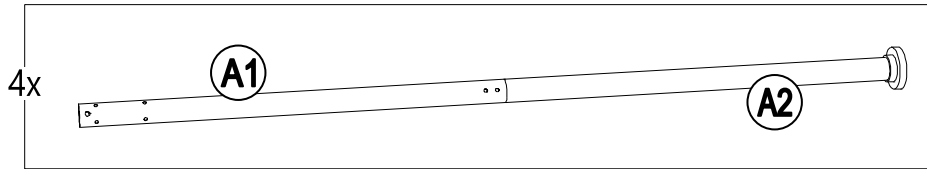
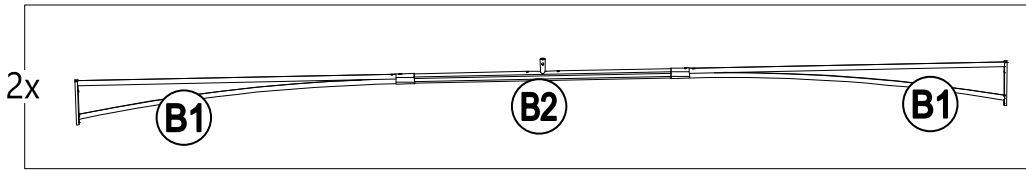

5

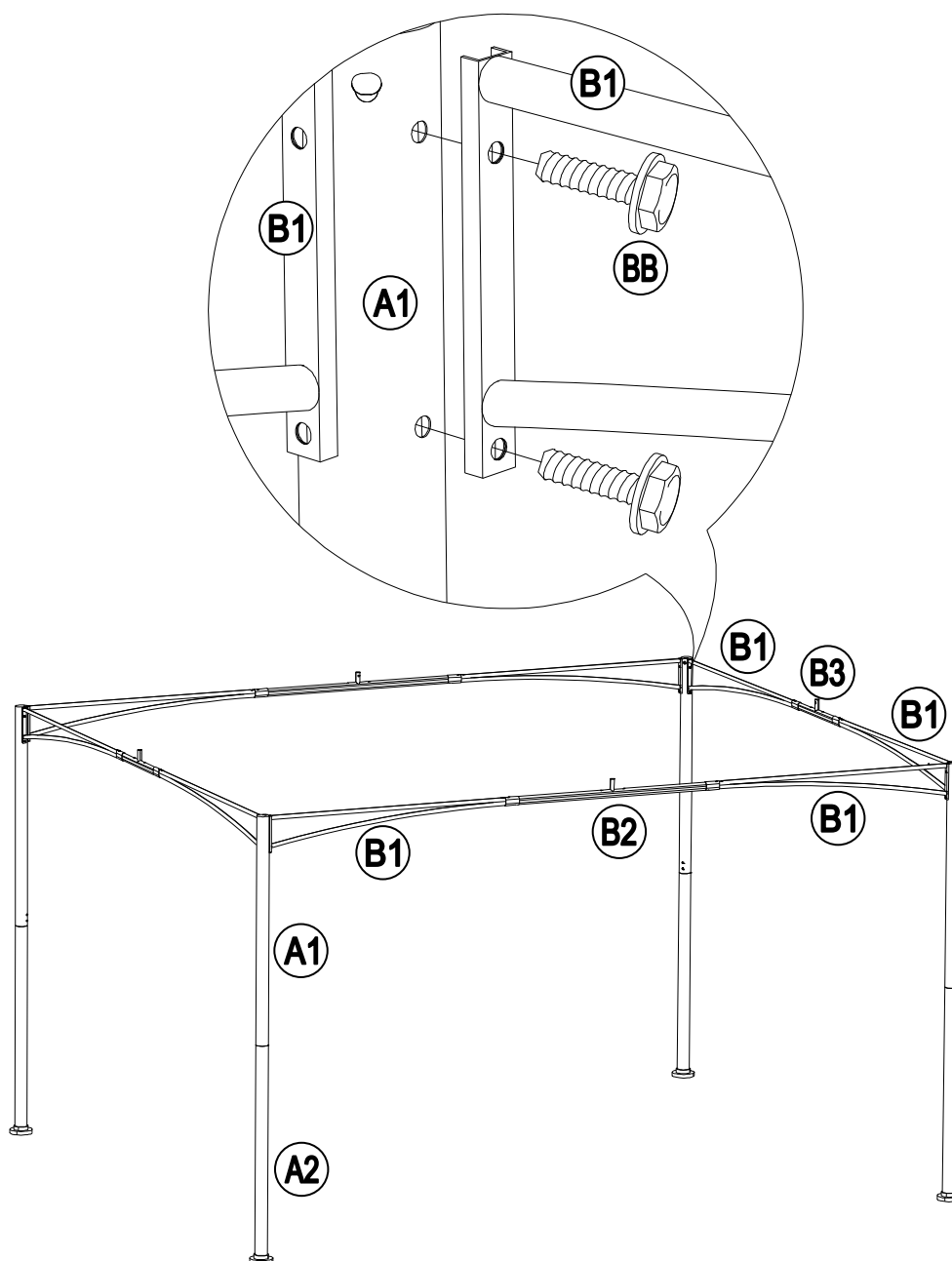
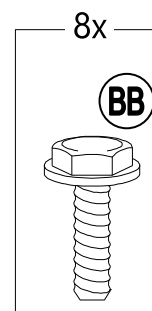
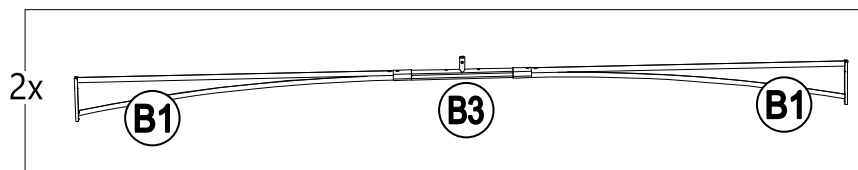

6

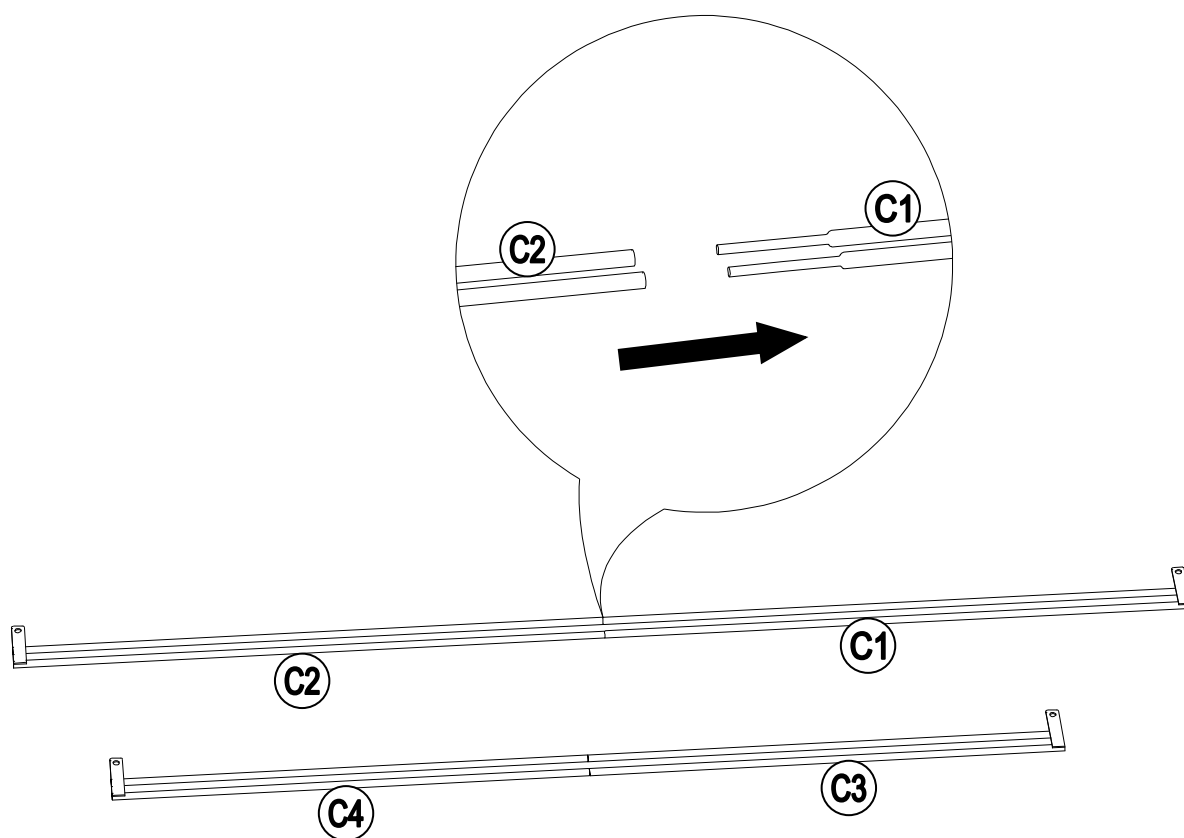
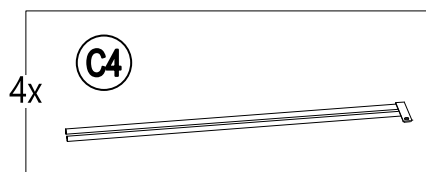
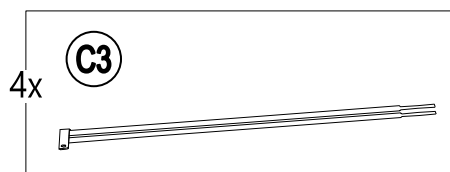
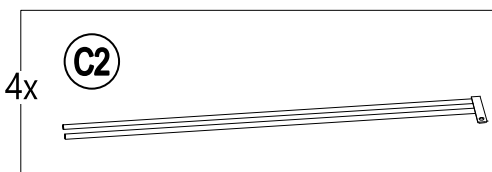
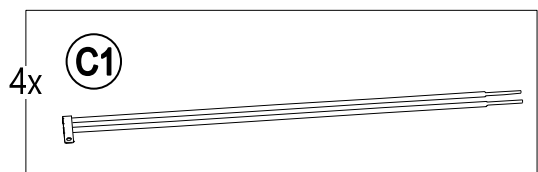

7

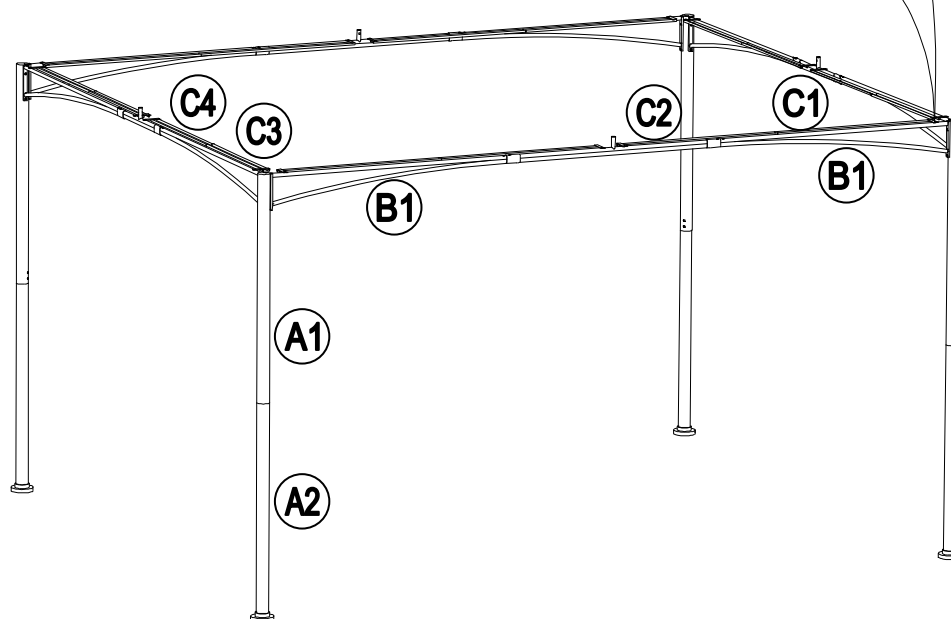
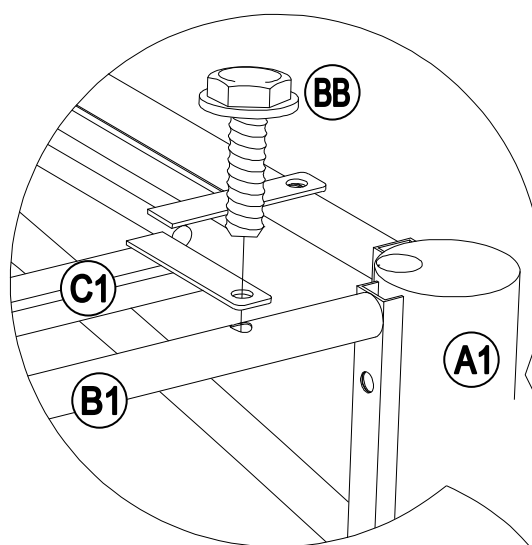
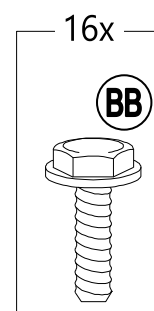
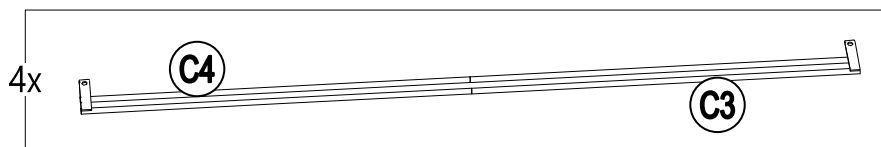
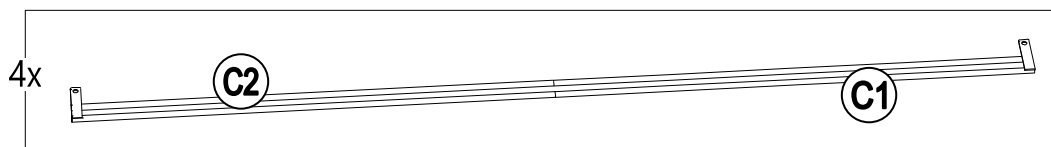

8

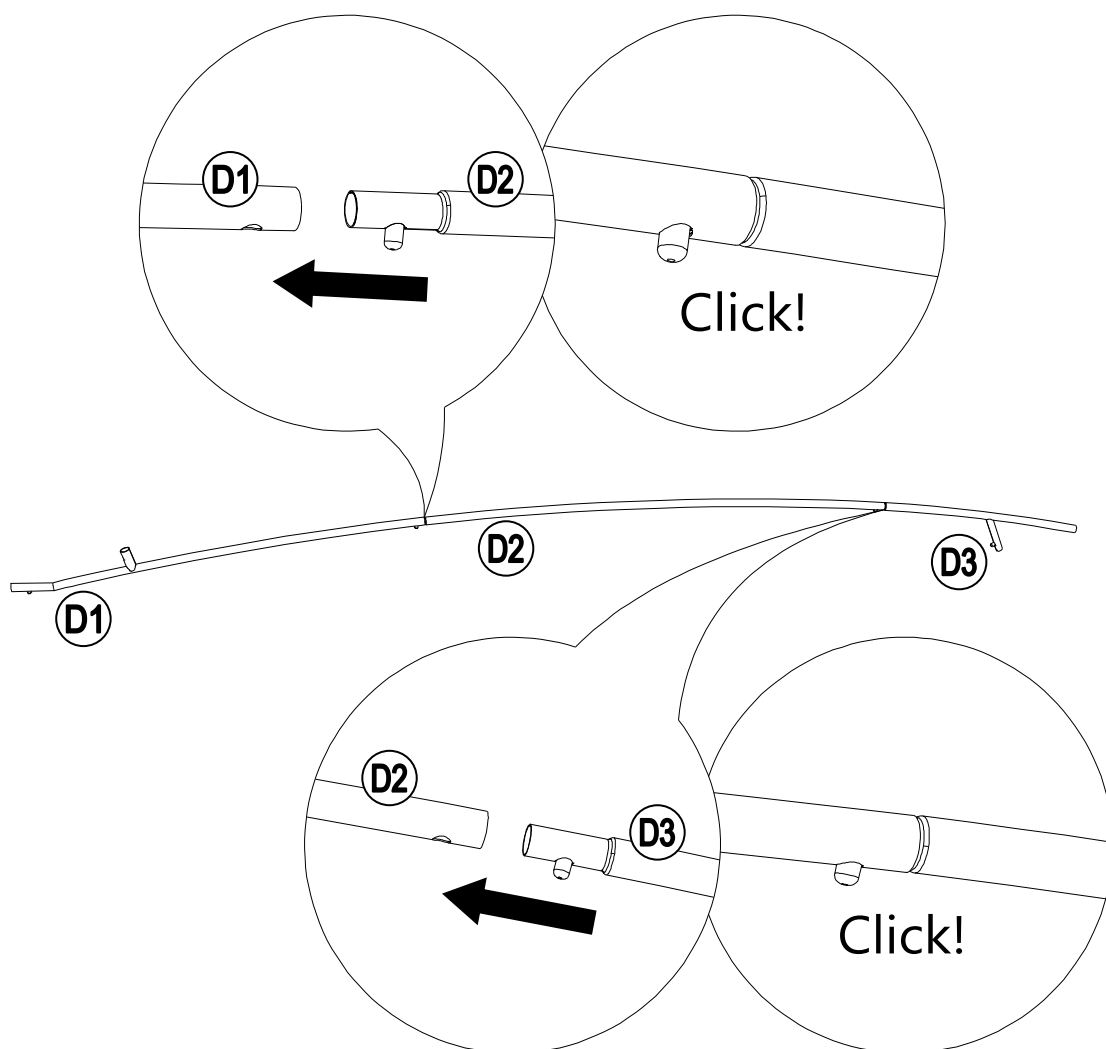
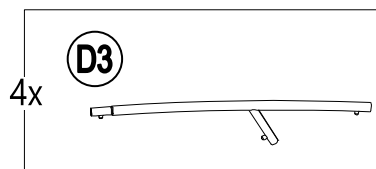
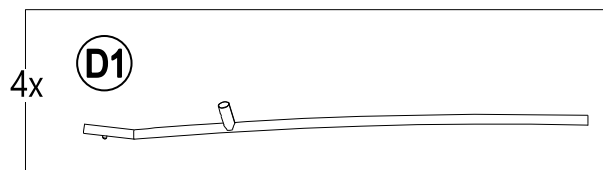

9

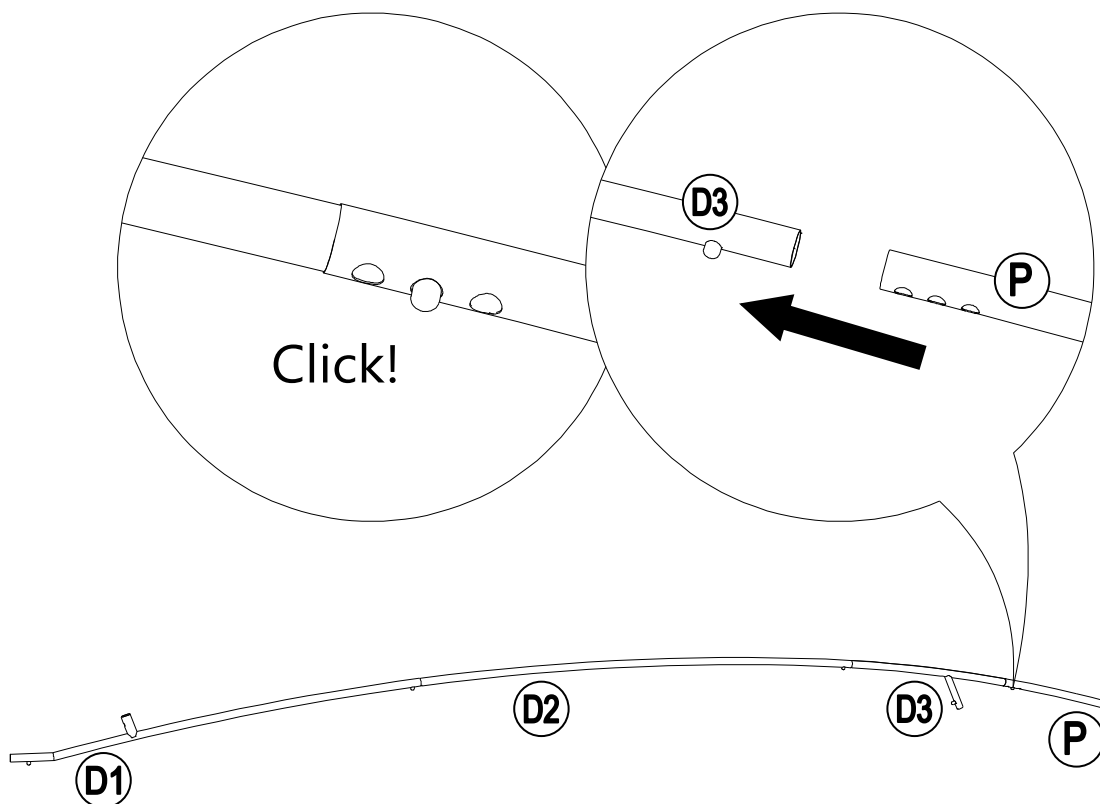
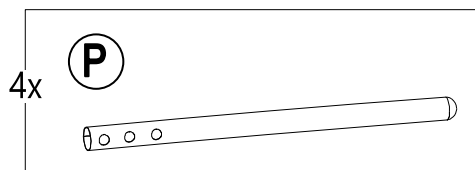

10

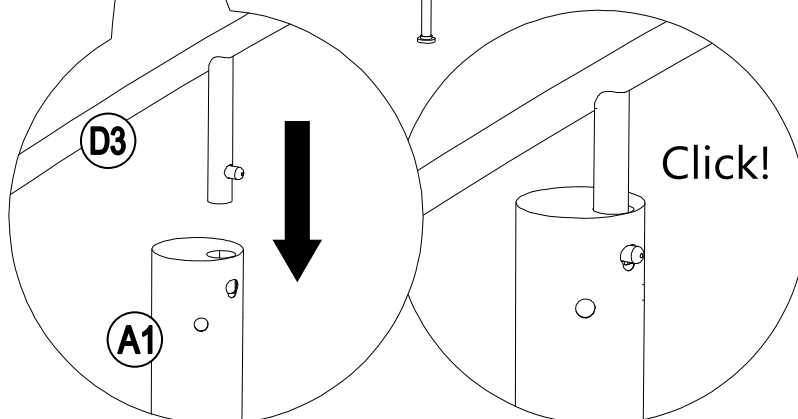
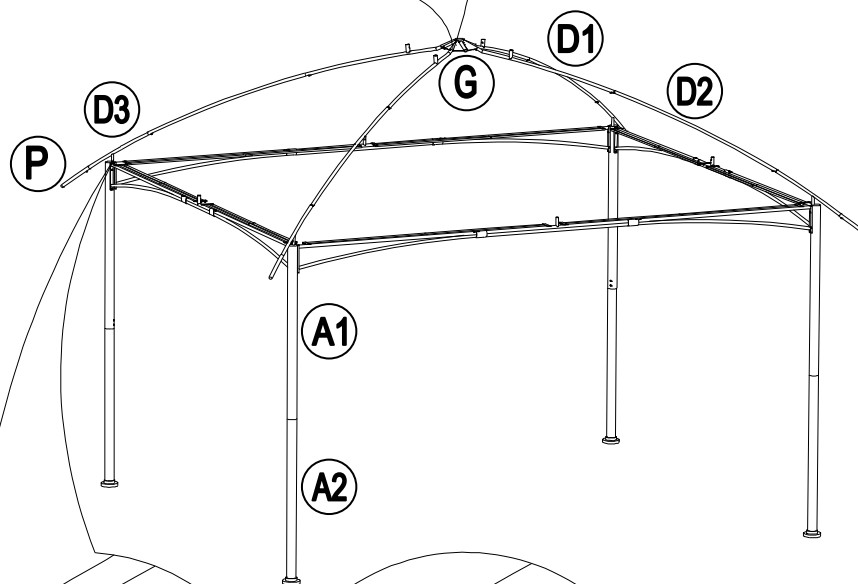
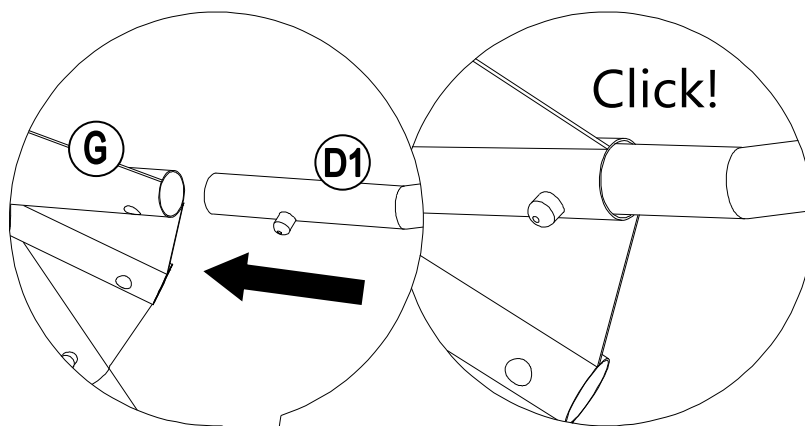
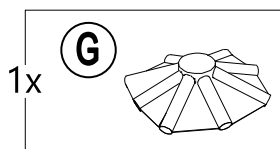
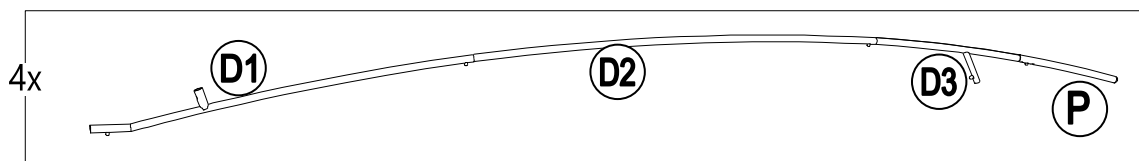

11

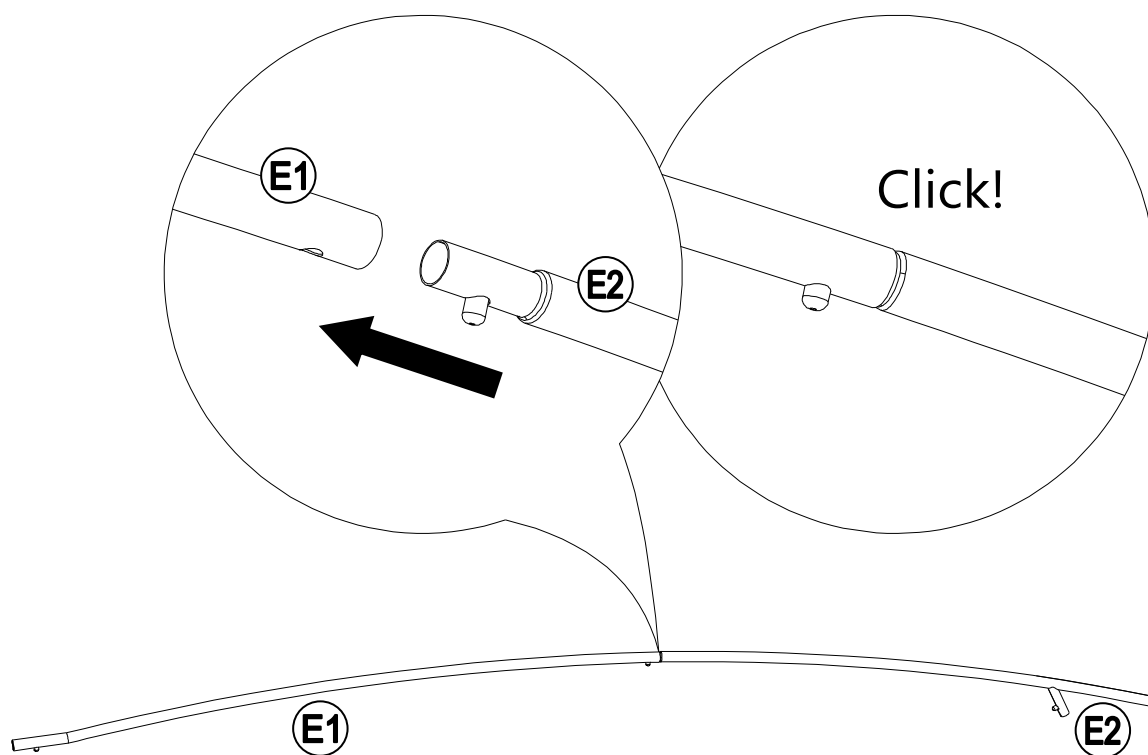

12

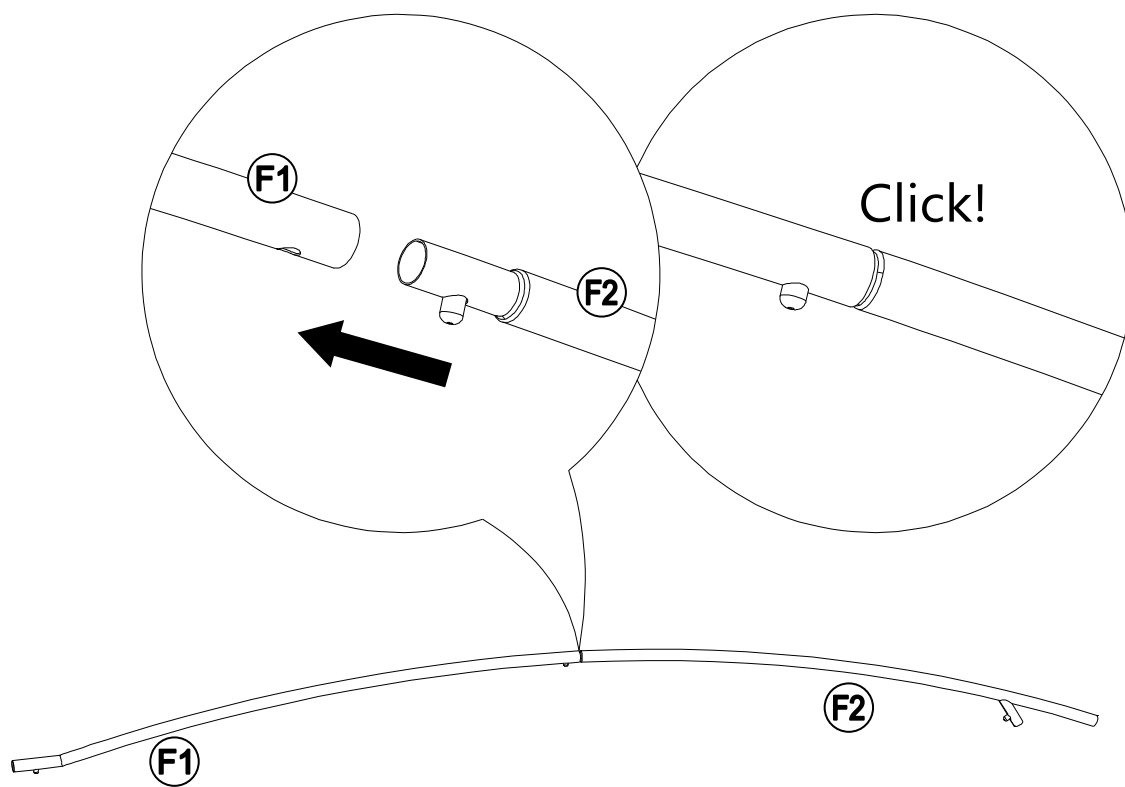

13

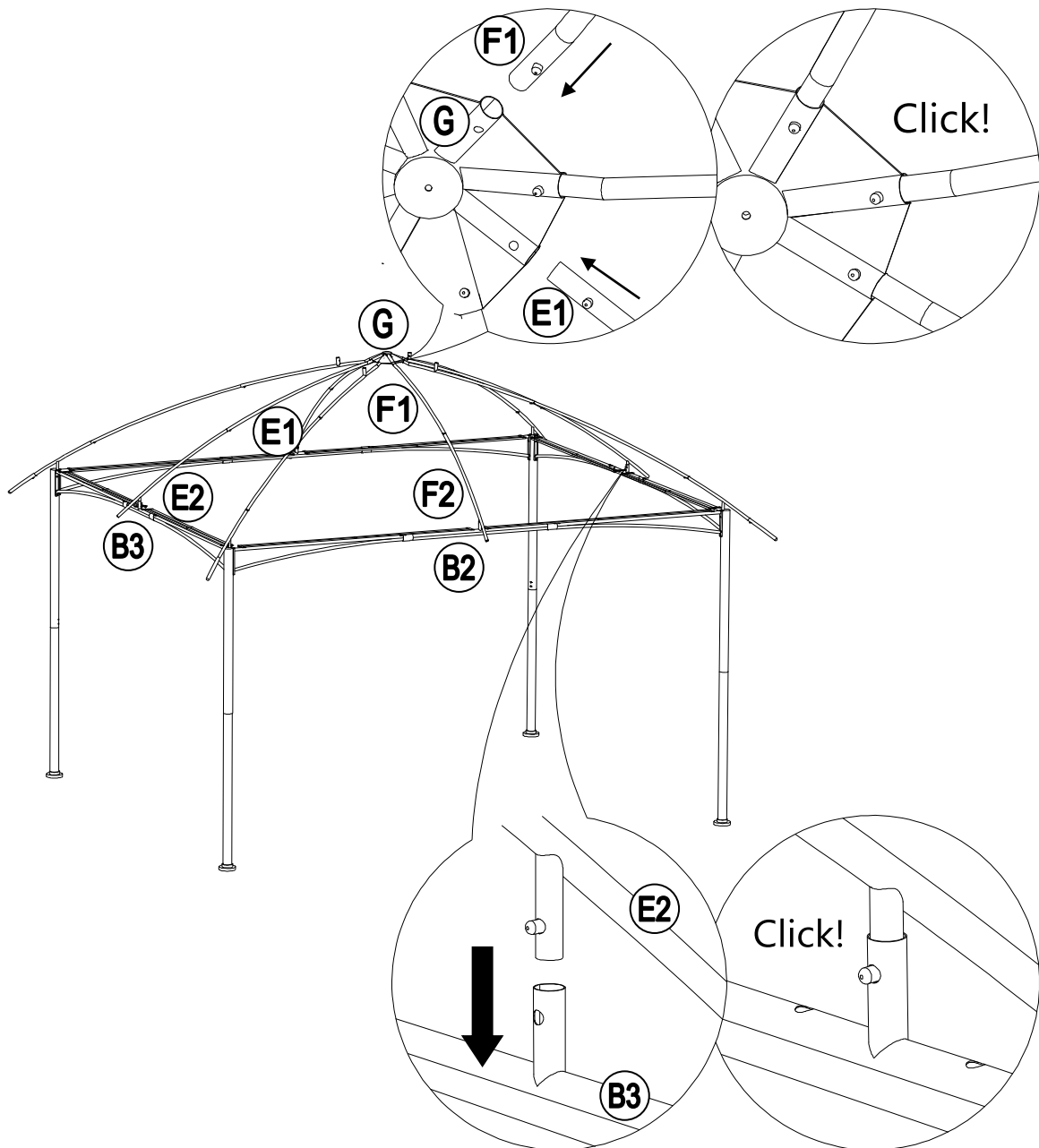
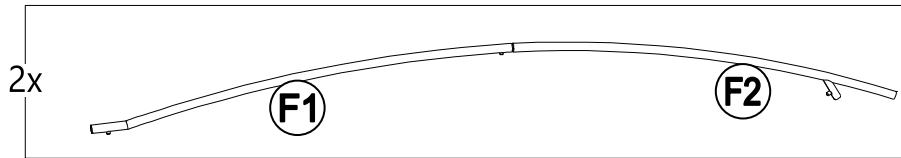
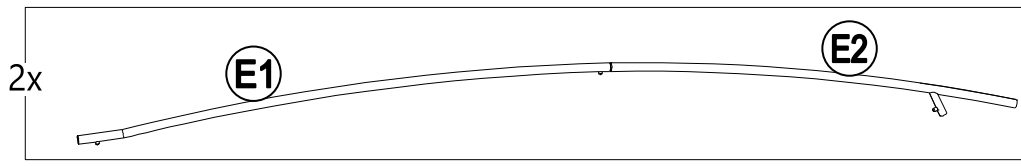

14

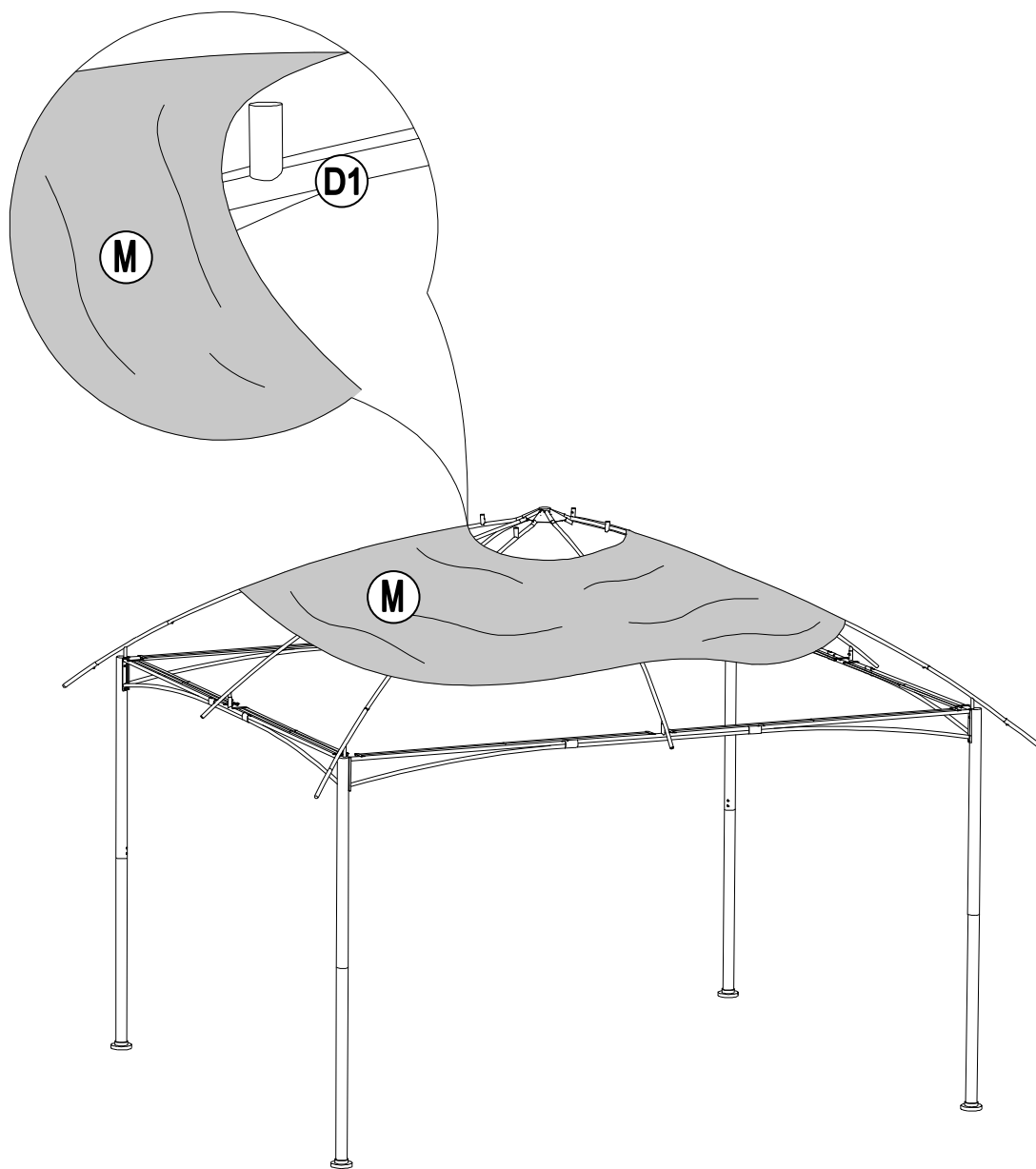
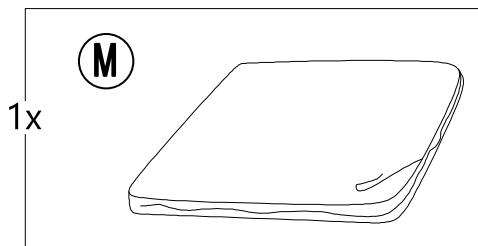

15

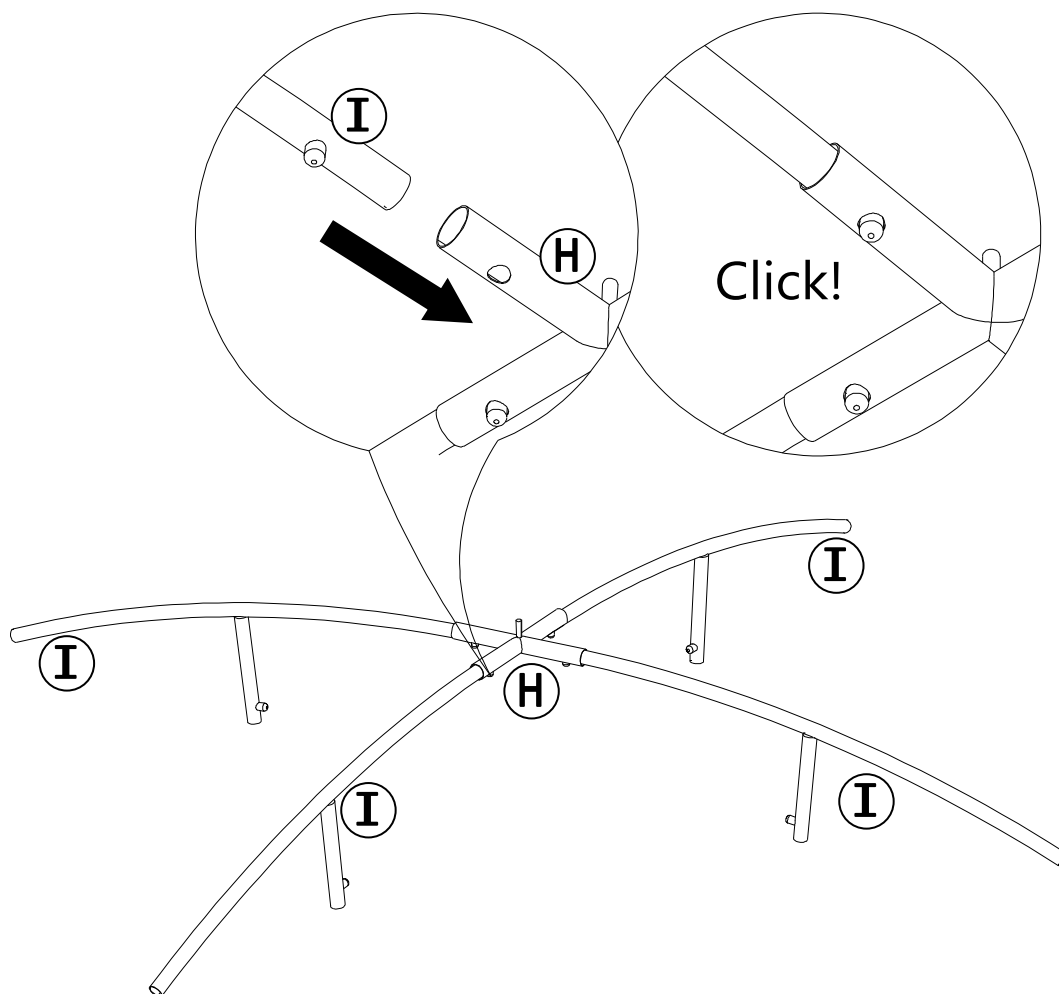
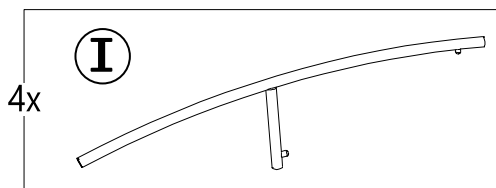
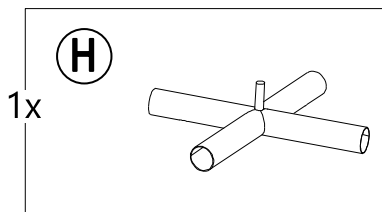

16

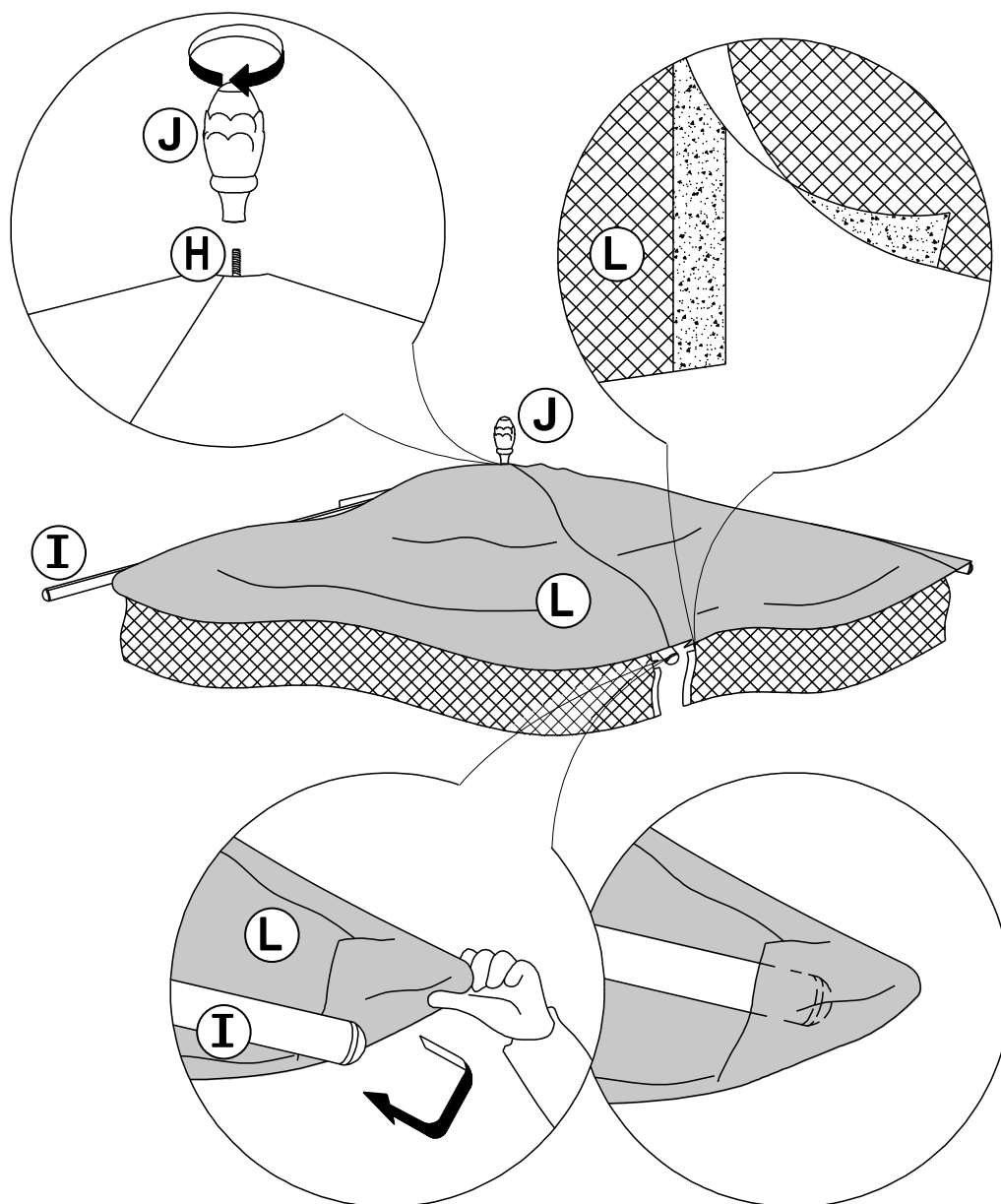
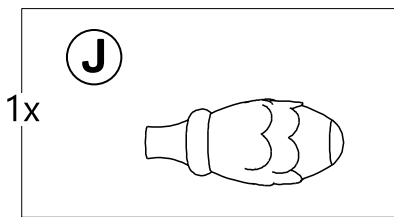
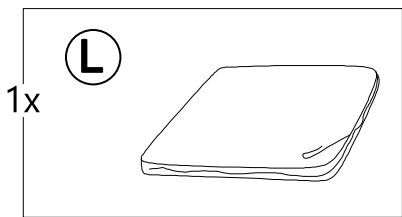

17

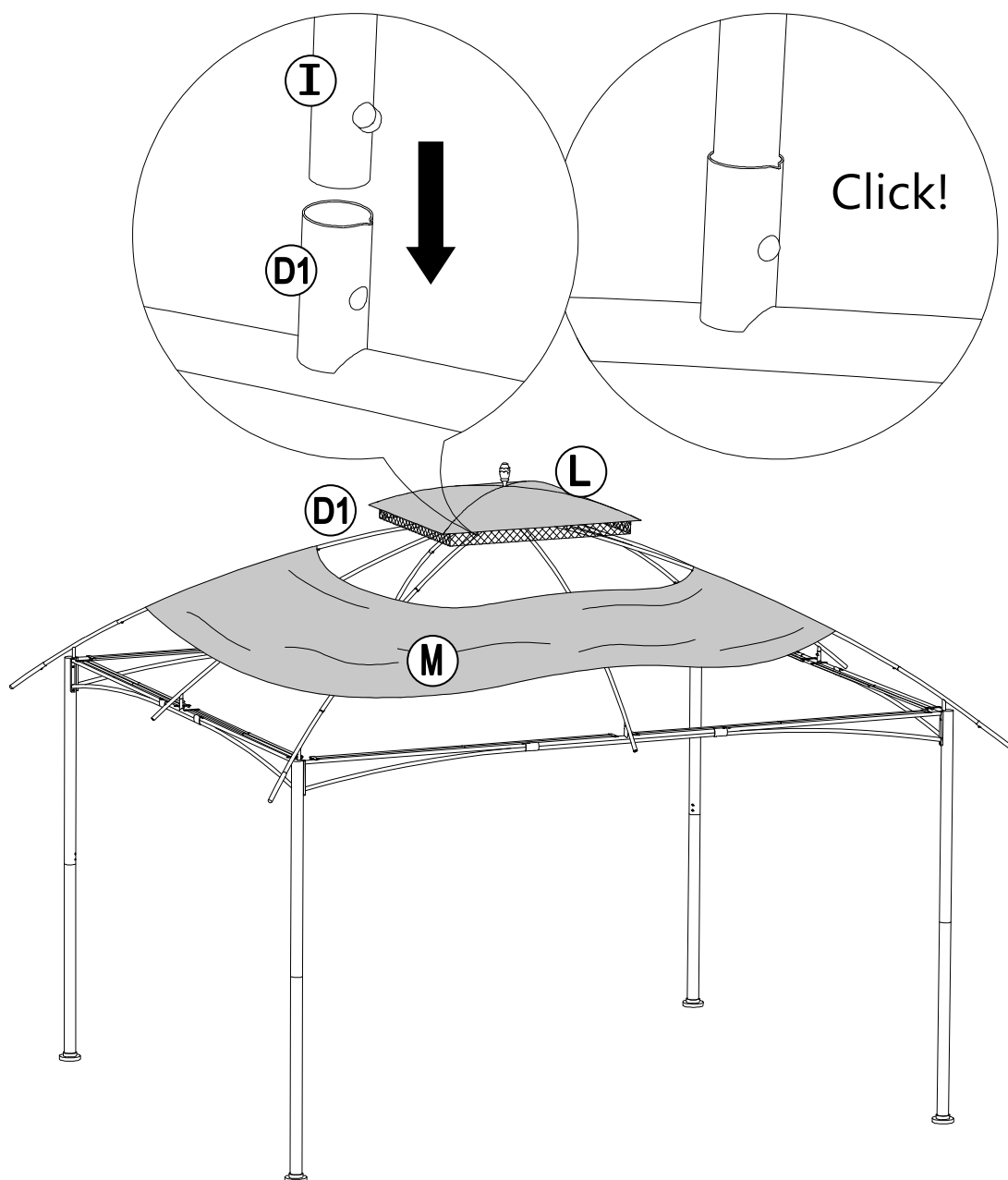

18

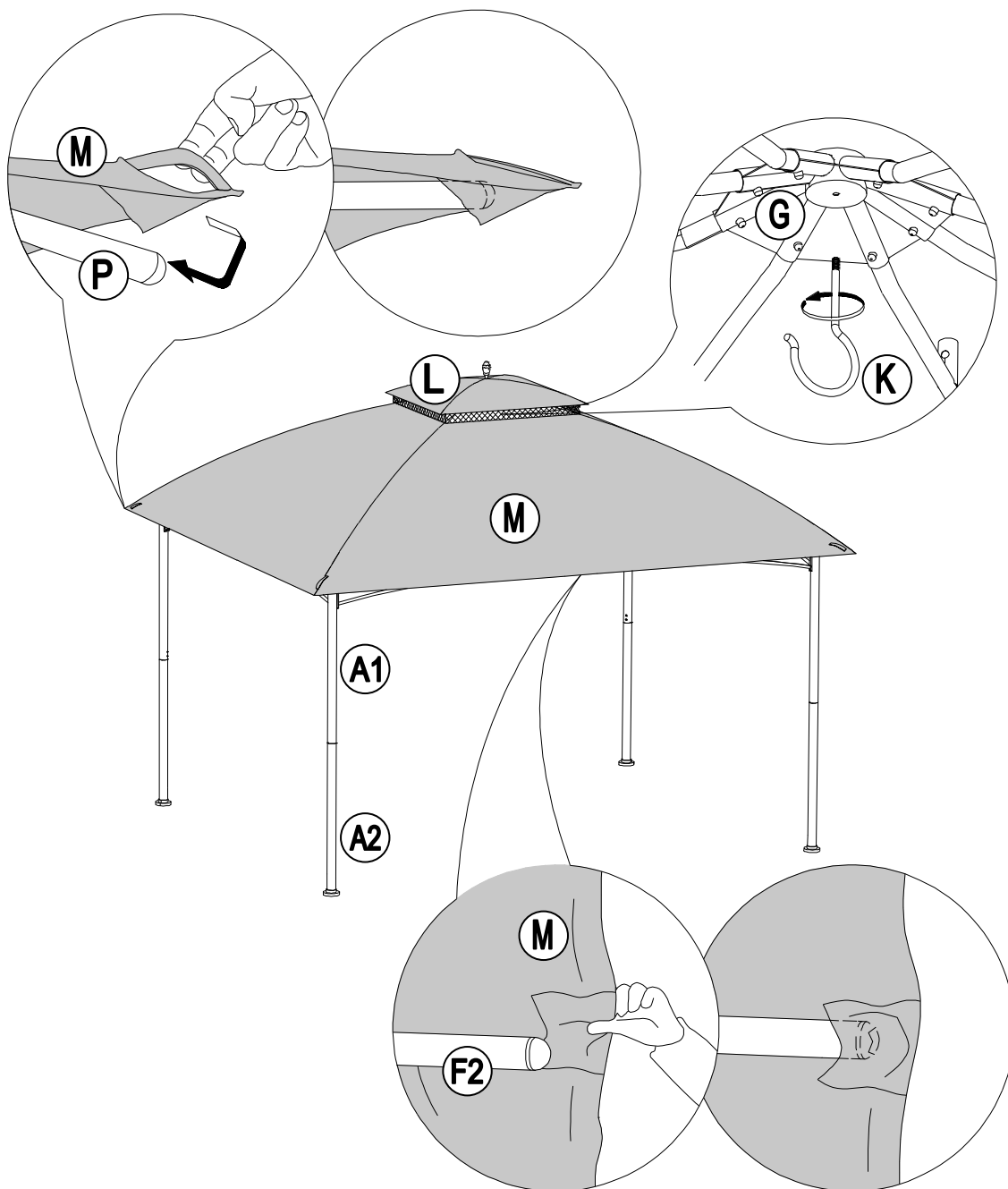
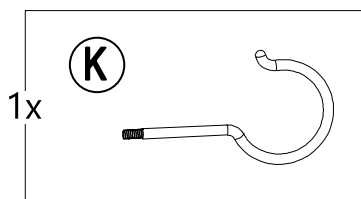

19

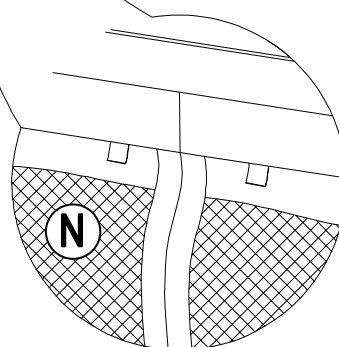
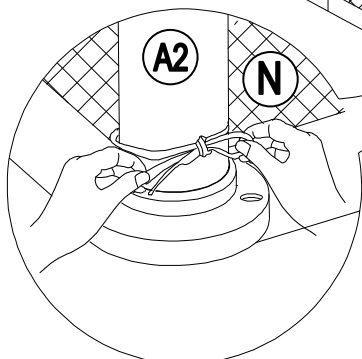
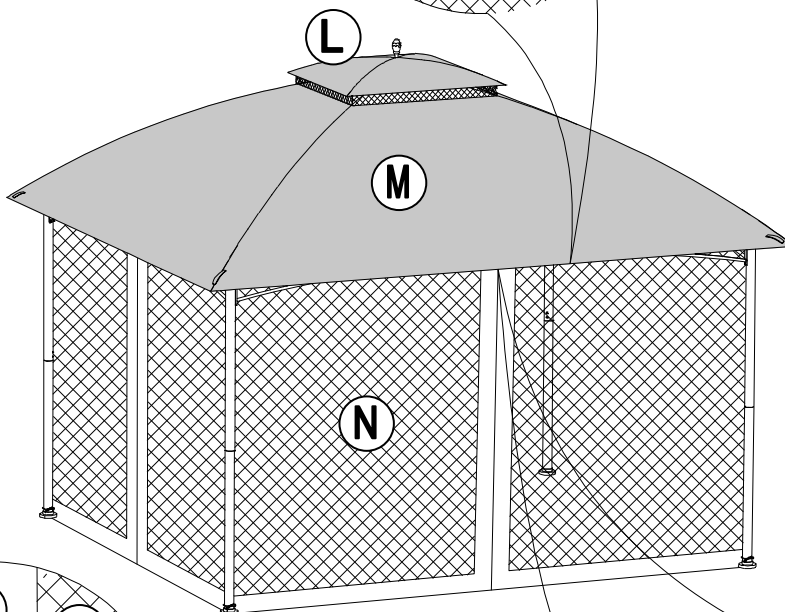
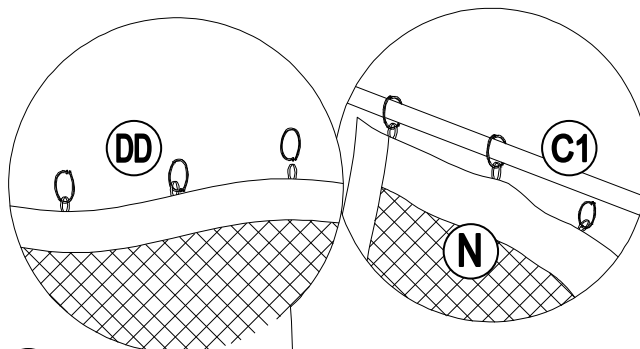
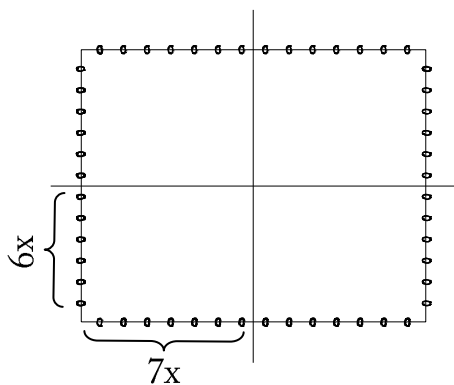
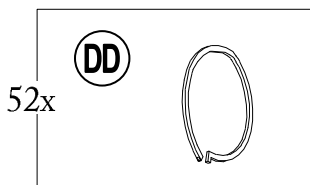
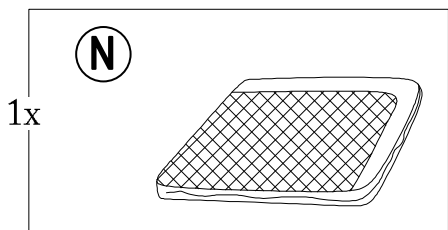

20

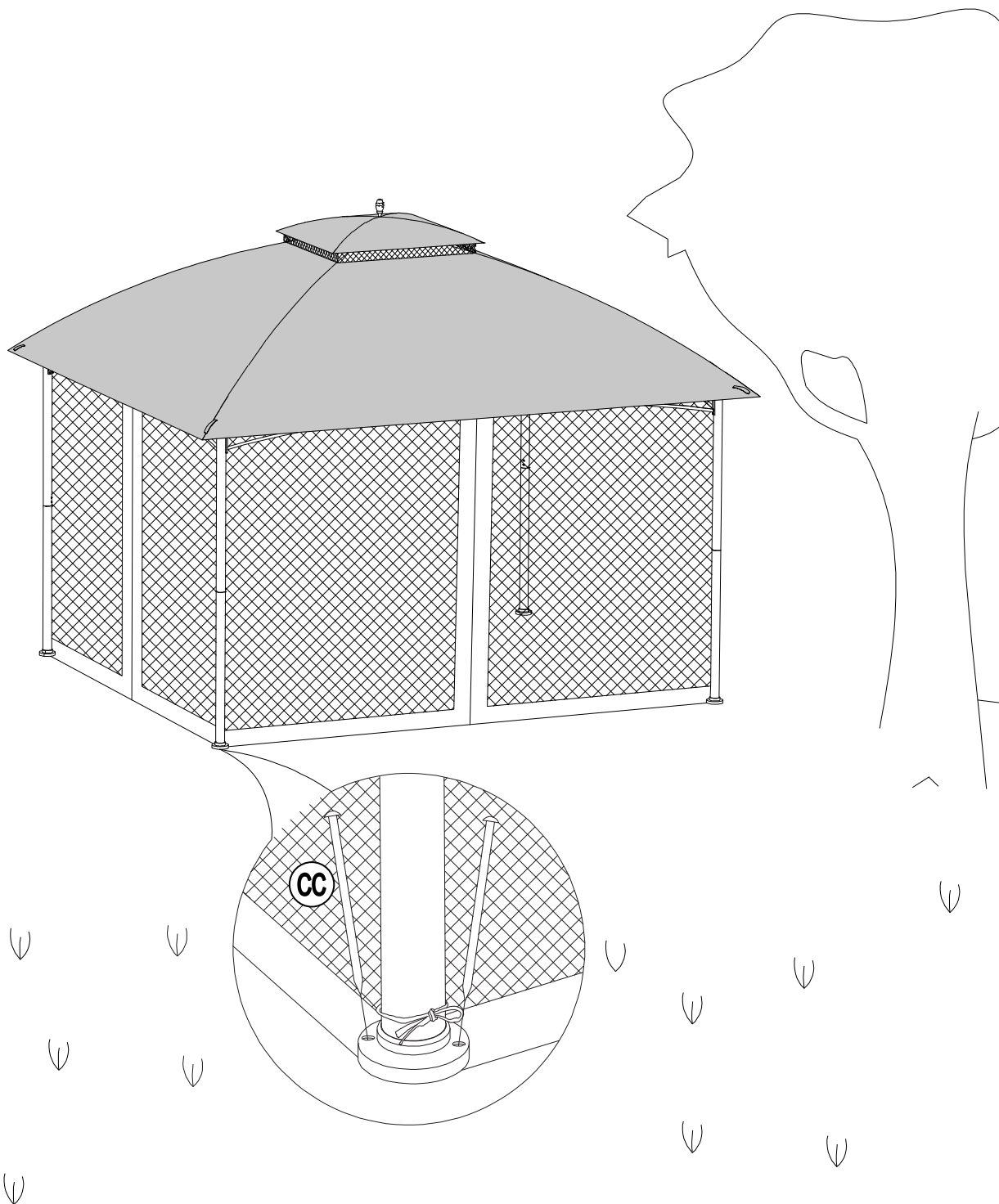
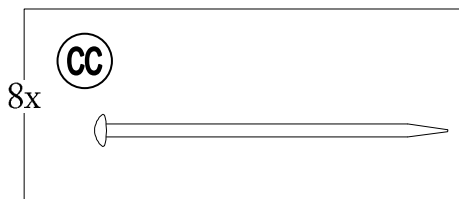

Care and Maintenance

Before using, clean the Chair completely with a soft dry towel. When not in use, wipe free of any dirt or loose objects, wash with a mild solution of soap and water; rinse thoroughly and dry completely. Do not use strong detergent or abrasive cleaners. Over time nuts and bolts can loosen. Occasionally, check nuts and bolts, re-tighten if necessary.

Limited Manufacturer's Warranty

We warrant to the original purchaser that this item is free from defects in workmanship and materials for a period of 1 year from the date of purchase, provided the item was factory-sealed at the time of purchase and is maintained with care and used only for personal, residential purposes. Should any manufacturing defect arise within this warranty period, We will replace (at our option) any defective merchandise or parts upon proof of purchase; however, transportation and delivery costs, as well as payments to a third party for assembly or disassembly of the item, remain the responsibility of the purchaser. A purchaser of an "open box," previously-returned, or "clearance" item, as well as original purchasers outside of the warranty period, may obtain replacement parts from us for products in current production, at nominal cost.

Exclusions

Items used for commercial, contract, or other non-residential purposes, or items damaged due to acts of nature, vandalism, misuse, or improper assembly are not covered. Corrosion or rusting of hardware is not covered. Proof of purchase (dated register receipt) is required for warranty claims. Warranty is to the original purchaser and is non-transferable. Any replacement of warranted items will be in the original style and color, or a similar style and color if the original is unavailable or has been discontinued. As some states do not allow exclusions or limitations on an implied warranty, the above exclusions and limitations may not apply. This warranty gives you specific rights, and you may also have other rights, which vary from state to state.